

Name: _____ Date: _____ Event: _____ Track: _____

Track Conditions

<input type="checkbox"/> Indoor	<input type="checkbox"/> Tight	<input type="checkbox"/> Smooth	<input type="checkbox"/> Hard Packed	<input type="checkbox"/> Blue Groove	<input type="checkbox"/> Wet	<input type="checkbox"/> Low Bite	<input type="checkbox"/> High Bite
<input type="checkbox"/> Outdoor	<input type="checkbox"/> Open	<input type="checkbox"/> Rough	<input type="checkbox"/> Loose/Loamy	<input type="checkbox"/> Dry	<input type="checkbox"/> Dusty	<input type="checkbox"/> Med Bite	<input type="checkbox"/> Other

Front Suspension

Ride Ht	
Camber	
Toe	
Sway Bar	
Notes:	

- 0mm
- 1mm
- 2mm

- 0mm
- 1mm
- 2mm

- PI AI
- 17.5 20

- 1mm
- 2mm

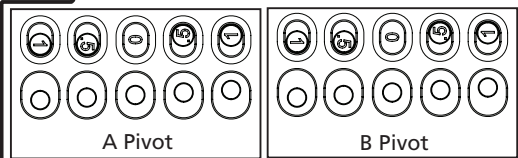
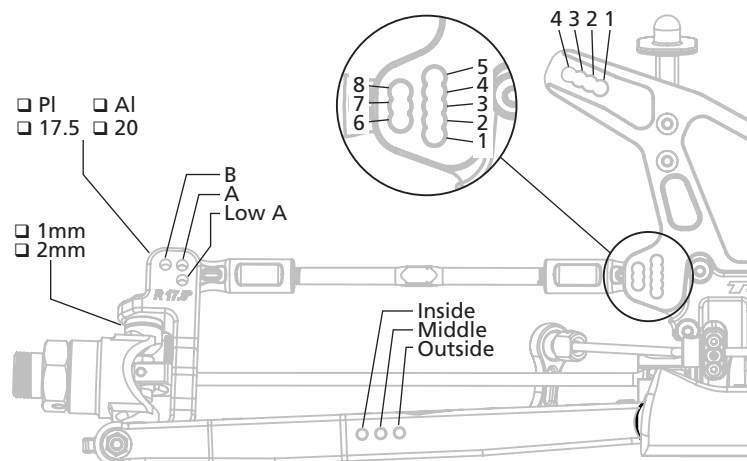
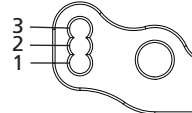
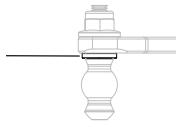
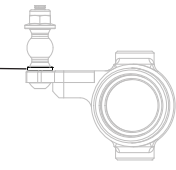

Rear Suspension

Ride Ht	
Camber	
Sway Bar	
Notes:	

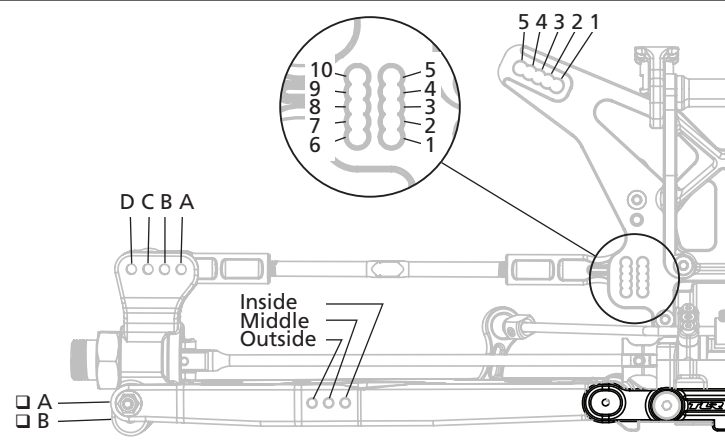
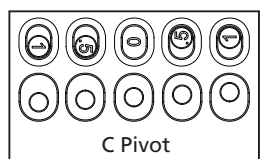
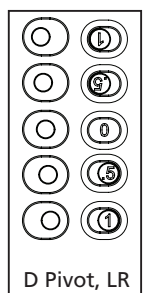
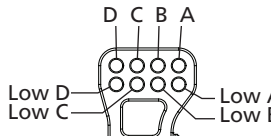

Chassis

Differentials	Front	Center	Rear
Fluid			
Pins	<input type="checkbox"/> AL <input type="checkbox"/> STL	<input type="checkbox"/> AL <input type="checkbox"/> STL	<input type="checkbox"/> AL <input type="checkbox"/> STL
Case	<input type="checkbox"/> STD <input type="checkbox"/> HD	<input type="checkbox"/> STD <input type="checkbox"/> HD	<input type="checkbox"/> STD <input type="checkbox"/> HD

Shocks	Front	Rear
Shock Type	<input type="checkbox"/> Bladder <input type="checkbox"/> Re Bladder <input type="checkbox"/> Emulsion <input type="checkbox"/> Vented	<input type="checkbox"/> Bladder <input type="checkbox"/> Re Bladder <input type="checkbox"/> Emulsion <input type="checkbox"/> Vented
Shaft Dia	<input type="checkbox"/> 3.5 <input type="checkbox"/> 4.0	<input type="checkbox"/> 3.5 <input type="checkbox"/> 4.0
Piston		
Oil		
Spring		
Stroke		
Droop		

Tires	Front	Rear
Brand		
Tread		
Compound		
Insert		
Sauce		

Wing
Brand
<input type="checkbox"/> Wicker Bill

- None
- Composite
- Carbon

Engine and Clutch	Fuel
Engine	
Glow Plug	Head Clearance
Pipe/Header	Gearing
Clutch Shoes	Clutch Springs
Th Servo	St Servo
Rx Pack	Flywheel <input type="checkbox"/> AL <input type="checkbox"/> STL

